



www.yzdrain.com

NINGBO YIZE SANITARY WARE CO., LTD

No. 323, Chaoyang Road, Jiangshan Town, Ningbo City,
315191, Zhejiang Province, China.

Tel: +86-574-83001668

P.C: 315191

E-mail: info@yzdrain.com



SHOWER DRAINS

Catalogue 2025



COMPANY PROFILE



Ningbo Yize Sanitary Ware Co., Ltd founded in 2014, is located in Ningbo city – a major port and industrial hub in the east of Zhejiang province. Relying on the advantages of unique resource, we are devoted to the production, sales and related services of sanitary ware. In the process of innovation and development, Ningbo Yize Sanitary Ware has a keen insight into the development trend of the industry, integrates advantageous resources comprehensively, establishes a modern production base, builds a product development laboratory and production workshop that meets international standards. Furthermore, we build a series of sanitary ware solution system to meet the diversified demands of customers in the market. This will make us to move on the development speed of the enterprise at the forefront of the industry.

In order to cope with the competitor in the sanitary ware market, Ningbo Yize Sanitary Ware has attracted senior experts and established an experienced, skilled and formidable technical R&D team and introduced various international advanced technologies and equipment to seek technological innovation. At the same time, the quality of products upgraded to the standards of European and American. We always launch sanitary ware with

As a senior enterprise with the responsibility of a national brand, Ningbo Yize Sanitary Ware sublimates the value of the development of national brand with the passion of continuous entrepreneurship. With the initial intention of letting more people to understand China's manufacturing through our enterprise, we have built a product sales network that covers worldwide, and accumulate the power of scientific and technological innovation to work hard to promote the development of national brands.





Our Advantage

R&D

Undergoing a series of strict procedures, our R&D team pays attention to innovation and sustainability in the future development. We have intelligent production system and international scientific research personnel.

Design

Underlining aesthetics and minimalism, we pursue the combination of product design and customer's needs. Our professional design team is committed to visually resonating with customers and providing them with more inspirations.

Quality Control

Numerous testings have been conducted to guarantee the quality and performance of product and material. By monitoring the whole production process, our professional team pursues perfection and breakthrough in details.

Capacity

With 1.2 million production volume, our production value can reach 10 million USD. Featured by efficient manufacturing technique, we can expand production line and achieve productivity improvement based on customer's needs.

After-Sales Service

We consider 'customer first' as our key policy, ranging from installation to replacement or return. Our professional customer support team will respond to inquires and settle problems as soon as possible.

Customization

Adopting the principle of customer first, we are committed to providing diversified personalized customization such as design, package. A series of one-stop solutions are provided to meet the different needs of customers in the market.

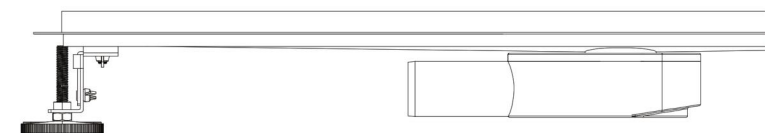

Contents .



360° Rotatable Outlet

Invisible Shower Drain	
Lomo Series	03—04
Slim Shower Drain	
Slimage Series	05—06
Linear Shower Drain	
FR Series	07—08

Horizontal Outlet

Stainless Linear Shower Drain	
A Series	09—10
Linear Wall Shower Drain	
C Series	11
E Series	11
Corner Shower Drain	
T Series	12
Square Shower Drain	
Q Series	12

Vertical Outlet

Strip Vertical Shower Drain	
D Series	13
DA Series	13
Triangular Shower Drain	
TD Series	14
Square Shower Drain	
QD Series	15
QDA Series	15
Covers	16—20

Shower Set

Thermostatic Series	
Concealed Shower Set	21—22
Thermostatic Shower Set	23—30
Thermostatic Mixer Shower Simple Set	31—34
Non-Thermostatic Series	
Non-thermostatic Shower	35
Non-thermostatic Shower Simple Set	36
Main part	
Thermostatic Main part	37—44
Non-thermostatic Main part	43—46

Bathroom Accessories

Niche	47—50
Pop-up Waste	51—54
Bottle-trap	55
Glass Squeegee	56



Superior Durability

Made with premium stainless steel, it is also manufactured by advanced technology, remaining stable and robust all the time. Brushed chrome surface brings about minimum maintenance and longer service life. It has great ability to resist corrosion, rust and scratch, remaining fresh even after several years.

SHOWER DRAIN ICONS

	Flexible Height Adjustment		High Water Displacement
	Diameter of Base Inlet		Anti Leakage and Corrosion
	Diameter of Base Outlet		High Quality of AISI 304

SHOWER DRAIN COLOR CLASSIFICATION

Dark Copper	Bright Copper	Light Copper	Brushed Rose Gold	Brushed Antique Copper	Brushed TitaniumGold	Antique Bronze
Antique Brass	Brushed Chrome Gold	Black	Gunmetal	Stainless Steel	White	





L Series | YZ-L01

Invisible Shower Drain

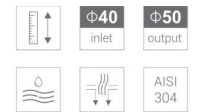

Specifications

Length/Width/Height:	300~3000mm/20mm/81~89mm
Thickness:	Base: 1.2mm Panel: 3mm
Material-Drain Body:	SS304
Flow Rate:	40L/min
Outlet Size:	40~50mm
Drainage Direction:	Horizontal
Adjustable Height:	Black Short: 65~80mm

Exploded View

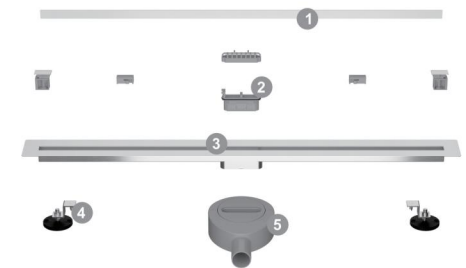

Dimensional Drawing

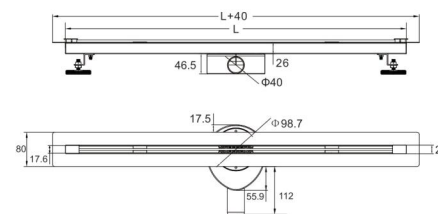

Accessories: 1: Cover 2: Hair Strainer
3: Base 4: Leveling Feet
5: 360° Connector



S Series | YZ-S01

Slim Shower Drain

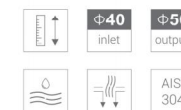

Specifications

Length/Width/Height:	300~3000mm/35mm/72mm
Thickness:	Base: 1.2mm Panel: 1.5mm
Material-Drain Body:	SS304
Flow Rate:	45L/min
Outlet Size:	40~50mm
Drainage Direction:	Horizontal
Adjustable Height:	Black Short: 65~80mm

Exploded View

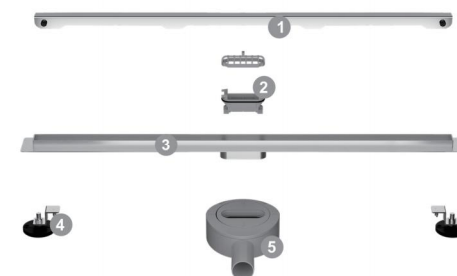

Dimensional Drawing

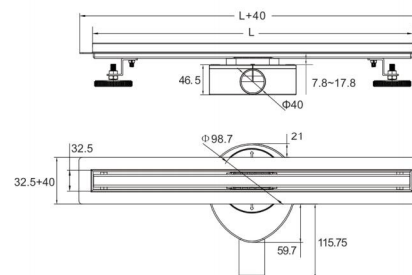

Accessories: 1: Cover 2: Hair Strainer
3: Base 4: Leveling Feet
5: 360° Connector



FR Series | YZ-FR02S

Linear Shower Drain



Specifications

Length/Width/Height:	300~3000mm/70mm/72mm
Thickness:	Base: 1.2mm Pattern Panel: 1.5mm Tile Panel: 1.0mm
Material-Drain Body:	SS304
Flow Rate:	45L/min
Outlet Size:	40~50mm
Drainage Direction:	Horizontal
Adjustable Height:	Black Short: 65~80mm

Dimensional Drawing

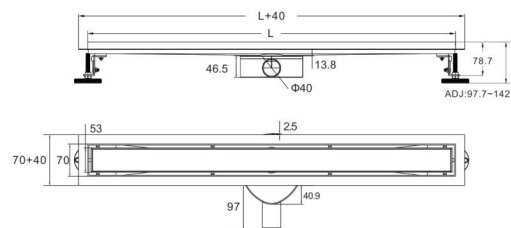

Exploded View

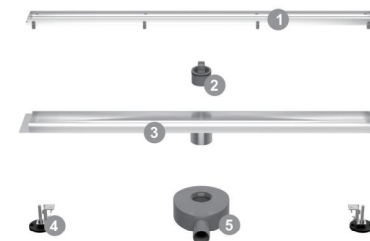

Accessories: 1: Cover 2: Hair Strainer
3: Base 4: Leveling Feet
5: 360° Connector

Suitable For:



A Series | YZ-A06

Stainless Linear Shower Drain

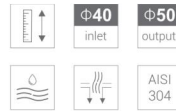

Specifications

Length/Width/Height:	300~3000mm/70mm/69mm
Thickness:	Base: 1.2mm Pattern Panel: 1.5mm Tile Panel: 1.0mm
Material-Drain Body:	SS304
Flow Rate:	35L/min
Outlet Size:	40~50mm
Drainage Direction:	Horizontal
Adjustable Height:	Black Short: 65~80mm

Exploded View



Accessories: 1: Cover 2: Hair Strainer
3: Base 4: Leveling Feet
5: Deodorant Siphon

Suitable For:

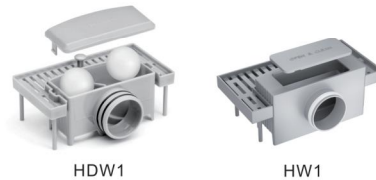

Dimensional Drawing

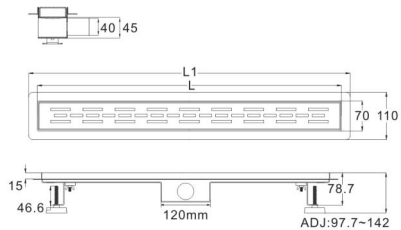

A Series | YZ-A09-15

Stainless Linear Shower Drain

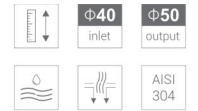
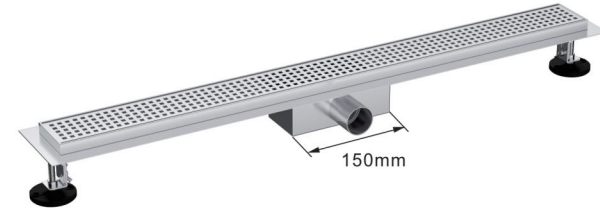

Specifications

Length/Width/Height:	300~3000mm/70mm/69mm
Thickness:	Base: 1.2mm Pattern Panel: 1.5mm Tile Panel: 1.0mm
Material-Drain Body:	SS304
Flow Rate:	35L/min
Outlet Size:	40~50mm
Drainage Direction:	Horizontal
Adjustable Height:	Black Short: 65~80mm

Exploded View

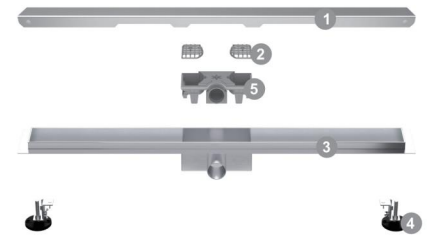

Accessories: 1: Cover 2: Hair Strainer
3: Base 4: Leveling Feet
5: Deodorant Siphon

Suitable For:

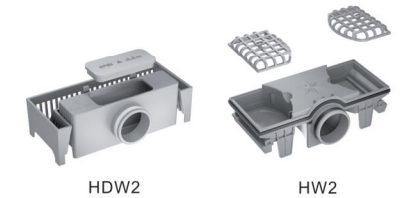

Dimensional Drawing

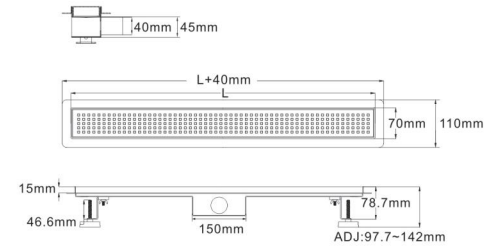

C Series | YZ-C01

Insert Wall Shower Drain



Length/Width/Height:	300~3000mm/72.2mm/151mm
Thickness:	Base: 1.2mm Panel: 1.0mm
Material-Drain Body:	SS304
Flow Rate:	35L/min
Outlet Size:	40~50mm
Drainage Direction:	Side-Drainage
Adjustable Height:	Black Short: 130~145mm

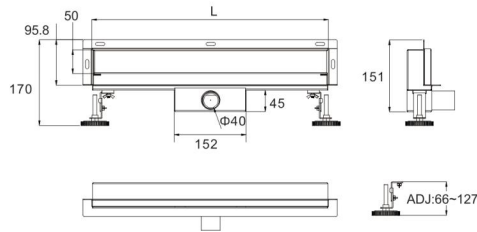

T Series | YZ-T03

Corner Shower Drain



Length/Width/Height:	200~300mm/200~300mm/75mm
Thickness:	Base: 1.2mm Pattern Panel: 1.5mm Tile Panel: 1.0mm
Material-Drain Body:	SS304
Flow Rate:	35L/min
Outlet Size:	40~50mm
Drainage Direction:	Side-Drainage
Adjustable Height:	No Adjustment Foot
Adjustable Height:	Black Short: 65~80mm

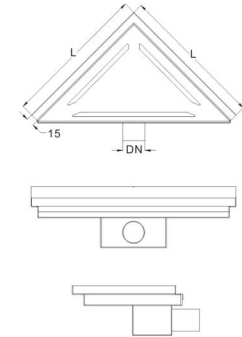

E Series | YZ-E02S

Linear Wall Shower Drain



Length/Width/Height:	300~3000mm/70mm/75mm
Thickness:	Base: 1.2mm Pattern Panel: 1.5mm Tile Panel: 1.0mm
Material-Drain Body:	SS304
Flow Rate:	35L/min
Outlet Size:	40~50mm
Drainage Direction:	Side-Drainage
Adjustable Height:	Black Short: 65~80mm

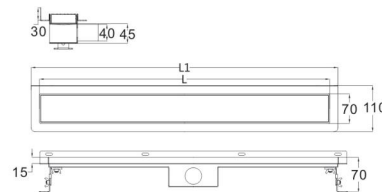

Q Series | YZ-Q02S

Square Shower Drain



Length/Width/Height:	100~300mm/100~300mm/78mm
Thickness:	Base: 1.2mm Pattern Panel: 1.5mm Tile Panel: 1.0mm
Material-Drain Body:	SS304
Flow Rate:	35L/min
Outlet Size:	40~50mm
Drainage Direction:	Side-Drainage
Adjustable Height:	Mental: 65~80mm Metal Adjustment Foot

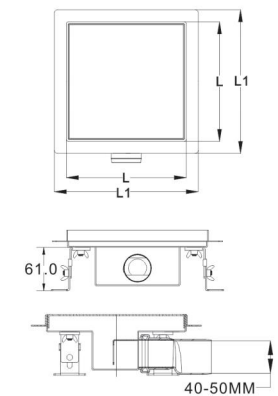

D Series | YZ-D09

Strip Vertical Shower Drain

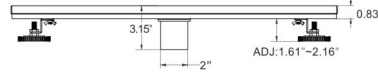
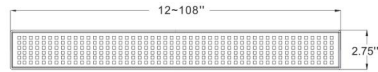

Length:	12~108"
Width:	2.75"/3"/3.25"
Height:	3.15"
Thickness:	Base: 18G Pattern Panel: 16G Tile Panel: 20G
Material-Drain Body:	SS304
Flow Rate:	60L/min
Outlet Size:	2"
Drainage Direction:	Vertical
Adjustable Height:	Black Short: 1.61~2.16"

TD Series | YZ-TD09

Triangular Shower Drain

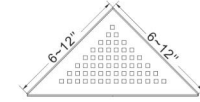
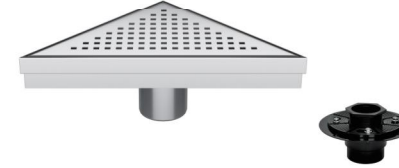

Length:	6~12"
Width:	6~12"
Height:	3.15"
Thickness:	Base: 18G Pattern Panel: 16G Tile Panel: 20G
Material-Drain Body:	SS304
Flow Rate:	60L/min
Outlet Size:	2"
Drainage Direction:	Vertical

DA Series | YZ-DA09

Strip Vertical Shower Drain

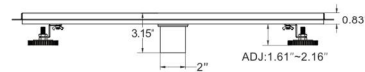
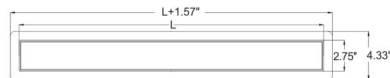

Length:	12~120"
Width:	2.75"/3"/3.25"
Height:	3.15"
Thickness:	Base: 18G Pattern Panel: 16G Tile Panel: 20G
Material-Drain Body:	SS304
Flow Rate:	60L/min
Outlet Size:	2"
Drainage Direction:	Vertical
Adjustable Height:	Black Short: 1.61~2.16"

SELECTION OF TRIANGLE GRATE COVERS



T03

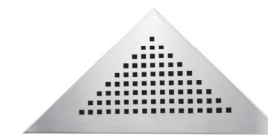

T09

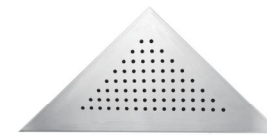

T08

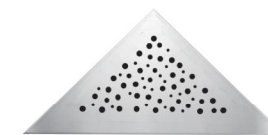

TL06

QD Series | YZ-QD06S

Square Shower Drain

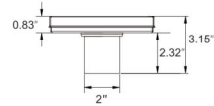
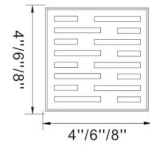

Length:	4 1/8"
Width:	4 1/8"
Height:	3.15"
Thickness:	Base: 18G Pattern Panel: 16G Tile Panel: 20G
Material-Drain Body:	SS304
Flow Rate:	60L/min
Outlet Size:	2"
Drainage Direction:	Vertical

QDA Series | YZ-QDA06S

Square Shower Drain

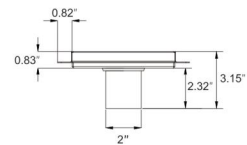
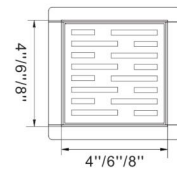

Length:	4 1/8"
Width:	4 1/8"
Height:	3.15"
Thickness:	Base: 18G Pattern Panel: 16G Tile Panel: 20G
Material-Drain Body:	SS304
Flow Rate:	60L/min
Outlet Size:	2"
Drainage Direction:	Vertical

SELECTION OF TRIANGLE GRATE COVERS



T03

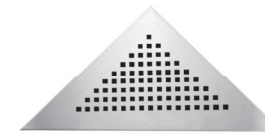

T09

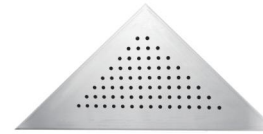

T08

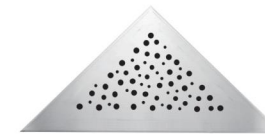

TL06

SELECTION OF SQUARE GRATE COVERS



Q02S



Q02S



Q02



Q02



Q02E



Q04



Q06S

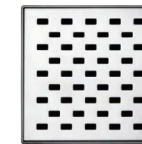

Q07



Q08

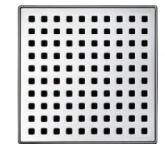

Q09



QG02





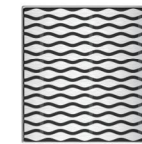





QG03









QG05

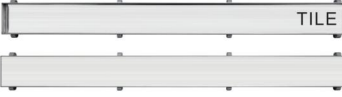







Grate Covers

Cover Model	Material	
G03	SS304/SS316	
G03-A	SS304/SS316	
G02	SS304/SS316	
L08	SS304/SS316	
24	SS304/SS316	
25	SS304/SS316	
26	SS304/SS316	
27	SS304/SS316	











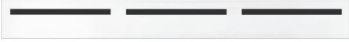



Grate Covers

Cover Model	Cover Model	Material	
Flat	01	SS304/SS316	
2 in 1 Pattern	02S	SS304/SS316	
Linie	06	SS304/SS316	
Capsular Grate	07	SS304/SS316	
Square	09	SS304/SS316	
Curve Wave	12	SS304/SS316	
Bubble	17	SS304/SS316	
Irregular	18	SS304/SS316	

Grate Covers

Cover Model	Cover Model	Material	
Ware	L01	SS304/SS316	
Curve	L04	SS304/SS316	
Drops	L06	SS304/SS316	
Greek	L11	SS304/SS316	
Leaves Line	L14	SS304/SS316	
Route	L15	SS304/SS316	
Fence	L16	SS304/SS316	
Glass	G01B/G01	Glass	 TEMPER GLASS  TEMPER GLASS

Grate Covers

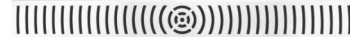
Item	Cover Model	Item	Cover Model
03		20	
04		21	
05		22	
08		L03	
L02		L05	
10		L08	
11		L10	
19		L13	



Thermostatic Series | TRC-101

Concealed Shower Set



Specifications

Color:	Chrome	
Body Material:	Brass	
Handle Material:	ABS	
Overhead shower Material:	SS	
Overhead shower size:	Φ200mm/Φ250mm	
Hand shower size:	Φ30×210mm	
The thickness of chrome plating:	Ni 6-8	Cr>0.2



Thermostatic Series | TSC-101

Concealed Shower Set



Specifications

Color:	Chrome	
Body Material:	Brass	
Handle Material:	ABS	
Overhead shower Material:	SS	
Overhead shower size:	200mm/250mm	
Hand shower size:	64×222mm	
The thickness of chrome plating:	Ni 6-8	Cr>0.2



Thermostatic Shower Set

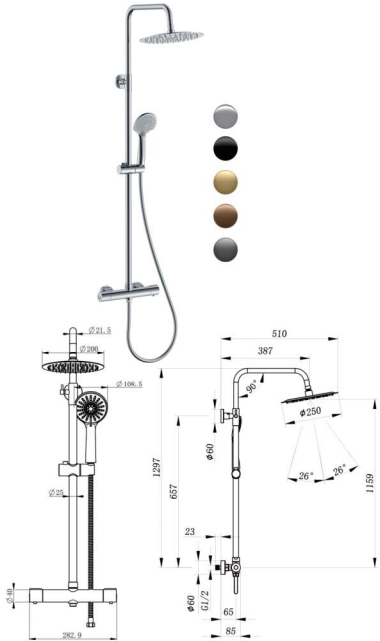

LYT-305

Specifications

Components: Thermostatic mixer, Shower rail, Hand shower holder, Overhead shower, With 3-mode hand shower, Shower hose, Installation accessories, Installation instructions

Color: Chrome/Matte black/Gun metal/Brushed brass
Overhead shower size: 10 inches
Hand shower size: Φ 108.5*242.5mm
Thermostatic valve: Φ 40*283mm

At3 bar pressure
Hand shower rate: 5.8L/min
Top spray flow rate: 11.5L/min
Working pressure range
Min working pressure: 0.5bar
Max working pressure: 5 bar
Constant temperature: $38\pm 2^{\circ}\text{C}$
Min temperature: $4-29^{\circ}\text{C}$
Max temperature: $55-85^{\circ}\text{C}$

Adjustable Angle
Adjustable riser rail
Bacteria Resistant
Easy cleaning shower head
Easy-cleaning Nozzles
ACS 24ACC NY438

Thermostatic Shower Set

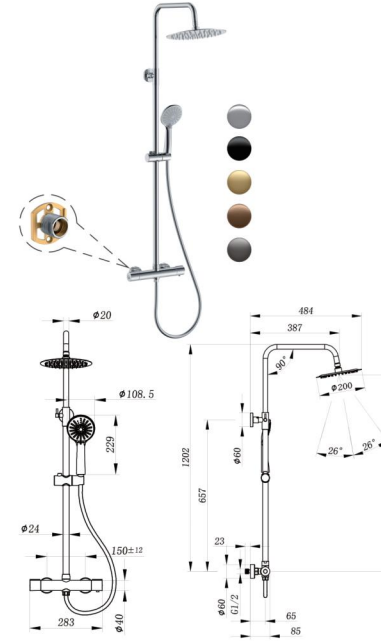

LYH-120

Specifications

Components: Thermostatic mixer, Shower rail, Hand shower holder, Overhead shower, With 3-mode hand shower, Shower hose, Installation accessories, Installation instructions

Color: Chrome/Matte black/Gun metal/Brushed brass
Overhead shower size: 8 inches
Hand shower size: Φ 108.5*242.5mm
Thermostatic valve: Φ 40*283mm

At3 bar pressure
Hand shower rate: 5.8L/min
Top spray flow rate: 10L/min
Working pressure range
Min working pressure: 0.5bar
Max working pressure: 5 bar
Constant temperature: $38\pm 2^{\circ}\text{C}$
Min temperature: $4-29^{\circ}\text{C}$
Max temperature: $55-85^{\circ}\text{C}$

Adjustable Angle
Adjustable riser rail
Bacteria Resistant
Easy cleaning shower head
Easy-cleaning Nozzles
ACS 24ACC NY438

LYT-306

Specifications

Components: Thermostatic mixer, Shower rail, Hand shower holder, Overhead shower, With 3-mode hand shower, Shower hose, Installation accessories, Installation instructions

Color: Chrome/Matte black/Gun metal/Brushed brass
Overhead shower size: 10 inches
Hand shower size: $80^{\circ}270\text{mm}$
Thermostatic valve: $40^{\circ}40^{\circ}283\text{mm}$

At3 bar pressure
Hand shower rate: 6.3L/min
Top spray flow rate: 11.3L/min
Working pressure range
Min working pressure: 0.5bar
Max working pressure: 5 bar
Constant temperature: $38\pm 2^{\circ}\text{C}$
Min temperature: $4-29^{\circ}\text{C}$
Max temperature: $55-85^{\circ}\text{C}$

Adjustable Angle
Adjustable riser rail
Bacteria Resistant
Easy cleaning shower head
Easy-cleaning Nozzles
ACS 24ACC NY438

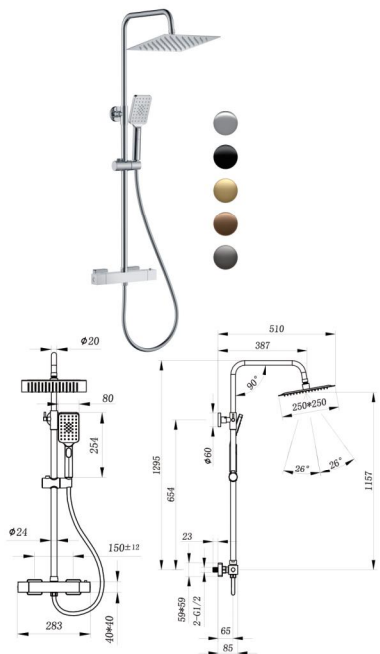

LYT-020

Specifications

Components: Thermostatic mixer, Shower rail, Hand shower holder, Overhead shower, Hand shower, Shower hose, Installation accessories, Installation instructions

Color: Chrome/Matte black/Gun metal/Brushed brass
Overhead shower size: 8 inches
Hand shower size: $64^{\circ}230\text{mm}$
Thermostatic valve: $40^{\circ}40^{\circ}283\text{mm}$

At3 bar pressure
Hand shower rate: 6.5L/min
Top spray flow rate: 10L/min
Working pressure range
Min working pressure: 0.5bar
Max working pressure: 5 bar
Constant temperature: $38\pm 2^{\circ}\text{C}$
Min temperature: $4-29^{\circ}\text{C}$
Max temperature: $55-85^{\circ}\text{C}$

Adjustable Angle
Adjustable riser rail
Bacteria Resistant
Easy cleaning shower head
Easy-cleaning Nozzles
ACS 24ACC NY438

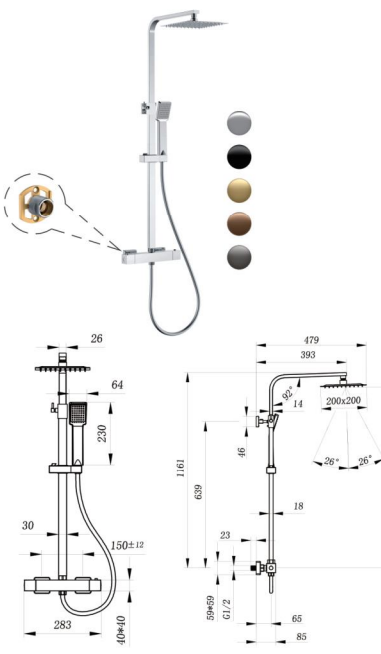

Thermostatic Shower Set

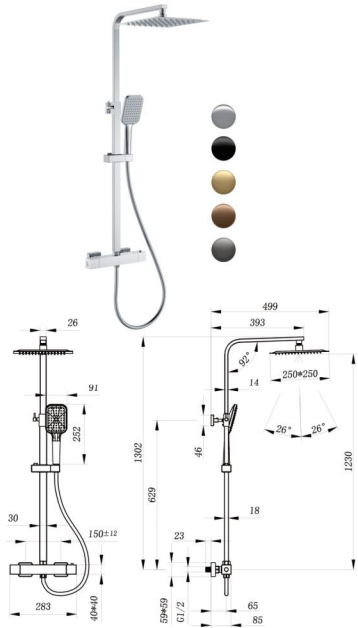

LYJ-020

Specifications

Components: Thermostatic mixer, Shower rail,
Hand shower holder, Overhead shower, Hand shower,
Shower hose, Installation accessories, Installation instructions

Color: Chrome/Matte black/Gun metal/Brushed brass
Overhead shower size: 10 inches
Hand shower size: 91*263mm
Thermostatic valve: 40*40*283mm

At3 bar pressure
Hand shower rate: 6.6L/min
Top spray flow rate: 10.5L/min
Working pressure range
Min working pressure: 0.5bar
Max working pressure: 5 bar
Constant temperature: 38±2°C
Min temperature: 4-29°C
Max temperature: 55-85°C

Adjustable Angle
Adjustable riser rail
Bacteria Resistant
Easy cleaning shower head
Easy-cleaning Nozzles
ACS 24ACC NY438

Thermostatic Shower Set

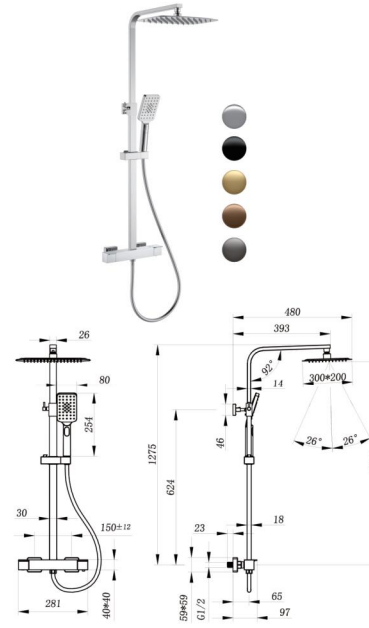

LDL-020

Specifications

Components: Thermostatic mixer, Shower rail,
Hand shower holder, Overhead shower, With 3-mode hand shower,
Shower hose, Installation accessories, Installation instructions

Color: Chrome/Matte black/Gun metal/Brushed brass
Overhead shower size: 300*200mm
Hand shower size: 80*270mm
Thermostatic valve: 40*40*281mm

At3 bar pressure
Hand shower rate: 6.5L/min
Top spray flow rate: 11.3L/min
Working pressure range
Min working pressure: 0.5bar
Max working pressure: 5 bar
Constant temperature: 38±2°C
Min temperature: 4-29°C
Max temperature: 55-85°C

Adjustable Angle
Adjustable riser rail
Bacteria Resistant
Easy cleaning shower head
Easy-cleaning Nozzles
ACS 24ACC NY438

LYJ-026

Specifications

Components: Thermostatic mixer, Shower rail,
Hand shower holder, Overhead shower, Hand shower,
Shower hose, Installation accessories, Installation instructions

Color: Chrome/Matte black/Gun metal/Brushed brass
Overhead shower size: 10 inches
Hand shower size: 91*263mm
Thermostatic valve: 40*40*283mm

At3 bar pressure
Hand shower rate: 6.1L/min
Top spray flow rate: 10.8L/min
Working pressure range
Min working pressure: 0.5bar
Max working pressure: 5 bar
Constant temperature: 38±2°C
Min temperature: 4-29°C
Max temperature: 55-85°C

Adjustable Angle
Adjustable riser rail
Bacteria Resistant
Easy cleaning shower head
Easy-cleaning Nozzles
ACS 24ACC NY438

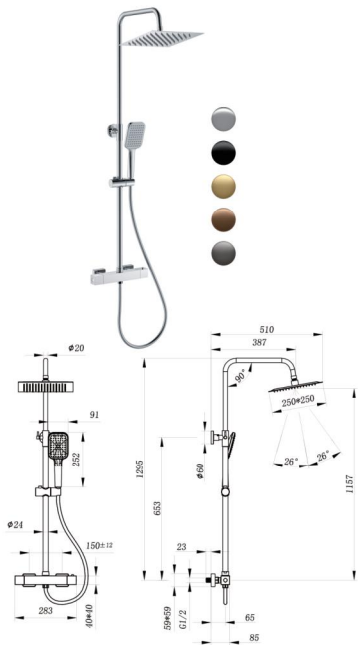

LDL-021

Specifications

Components: Thermostatic mixer, Shower rail,
Hand shower holder, Overhead shower, With 3-mode hand shower,
Shower hose, Installation accessories, Installation instructions

Color: Chrome/Matte black/Gun metal/Brushed brass
Overhead shower size: 300*200mm
Hand shower size: 80*270mm
Thermostatic valve: 40*40*281mm

At3 bar pressure
Hand shower rate: 6.5L/min
Top spray flow rate: 10.8L/min
Working pressure range
Min working pressure: 0.5bar
Max working pressure: 5 bar
Constant temperature: 38±2°C
Min temperature: 4-29°C
Max temperature: 55-85°C

Adjustable Angle
Adjustable riser rail
Bacteria Resistant
Easy cleaning shower head
Easy-cleaning Nozzles
ACS 24ACC NY438

